

**Specificaties / Spécifications
Spezifikationen / Specifications**

Sterkteklasse / Classe de résistance Festigkeitsklasse / Strength class	C55/67
Milieuklasse / Classe d'exposition Expositionsklasse / Exposure class	XC4, XS3, XD3, XF4, XA3
Omgevingsklasse / Classe d'environnement Umweltklasse / Environmental class	EE4, ES4, EA3
Betondekking / Enrobage de béton Betonabdeckung / Concrete cover	35 mm
Absorptie / Absorption Absorption / Absorption	< 5 %
Gewicht / Poids Gewicht / Weight	110 kg
Staalkwaliteit / Qualité de l'acier Stahlqualität / Steel quality	BE500ES

- A. Vlak - vlak
- A. Plat - plat
- A. Ebene - Ebene
- A. Flat - flat

- B. Smaller voor eenvoudige installatie
- B. Plus étroit pour pose aisée
- B. Schmäler für einfaches Verlegen
- B. Narrower for easy installation

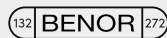

V052024

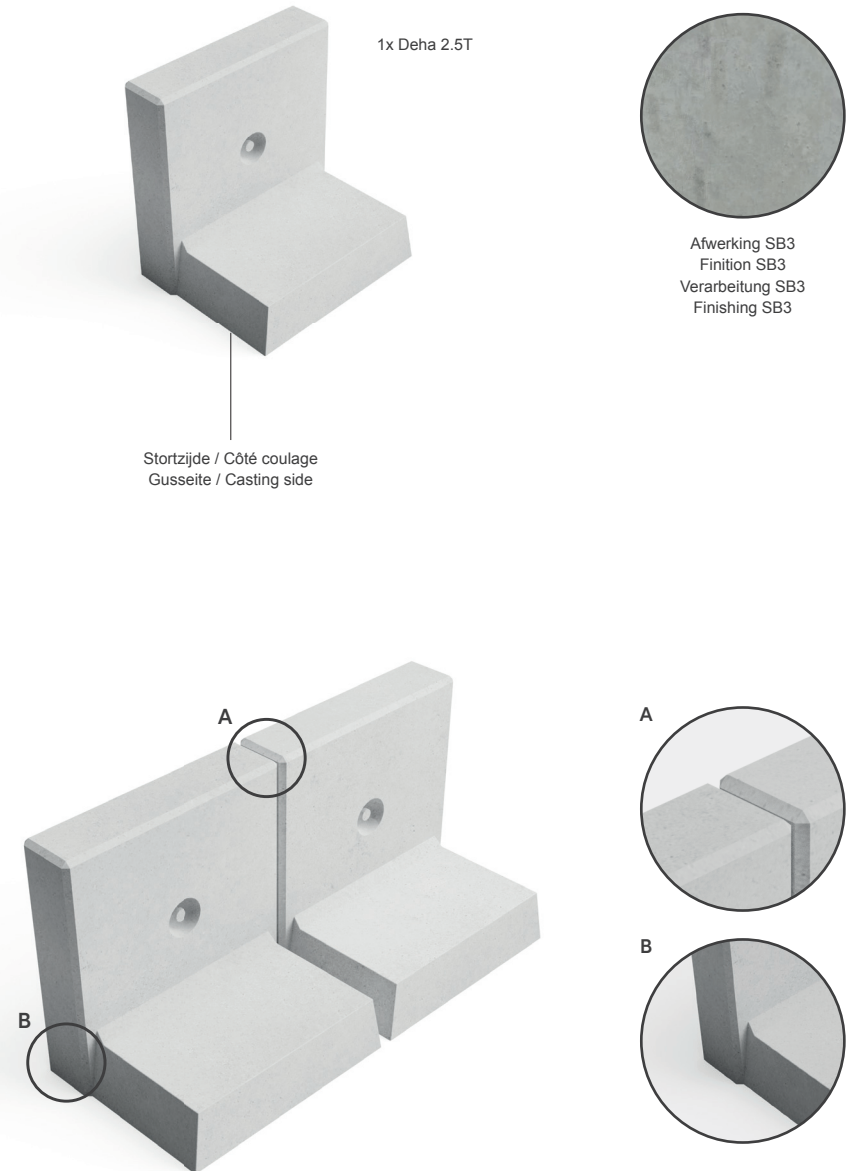

LP50/50

